

ITALIAN ATTITUDES TO ENERGY



BEHIND ENERGY SURVEY



SEE ENERGY PRODUCTION AND CONSUMPTION AS A CAUSE OF POLLUTION

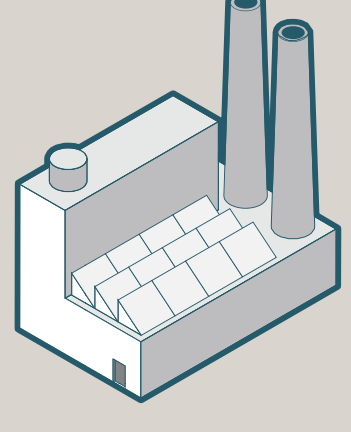

IDENTIFY POLLUTION AS ONE OF THE MAIN CAUSES OF DEATH



POLLUTION, NATURAL DISASTERS AND WASTE DISPOSAL ARE THE MAIN PROBLEMS CONNECTED WITH THE ENVIRONMENT

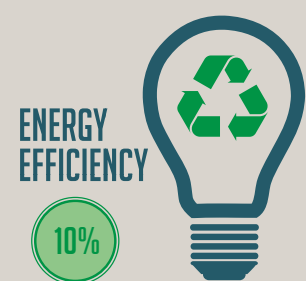
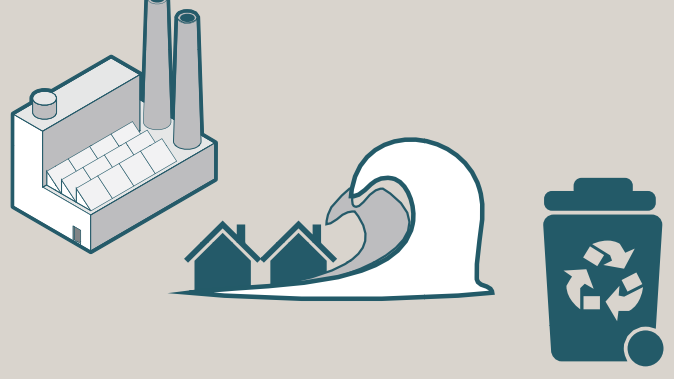

SAY RENEWABLE ENERGY SOURCES AND ENERGY EFFICIENCY ARE THE MAIN SOLUTION FOR RESOLVING ENERGY PROBLEMS



RENEWABLE ENERGY

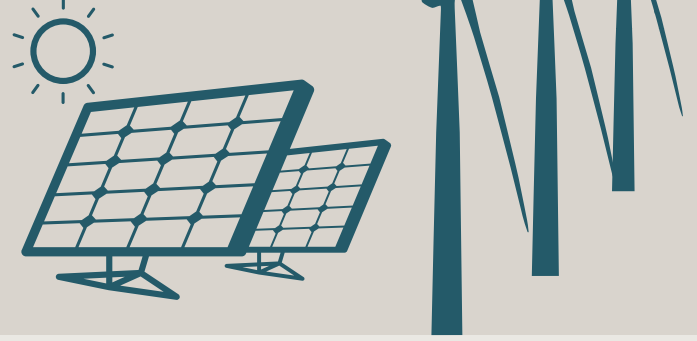

SAY THEY ARE INTERESTED IN ENERGY WHILE THE ECONOMIC CRISIS APPEARS TO HAVE CHANGED ITALIANS' PERSPECTIVES



THERE IS CONCERN ABOUT AN INCREASE IN ENERGY COSTS CAUSED BY THE END OF FOSSIL FUELS

ENERGY HAS A HIGH PERCEIVED IMPACT ON FAMILY BUDGETS

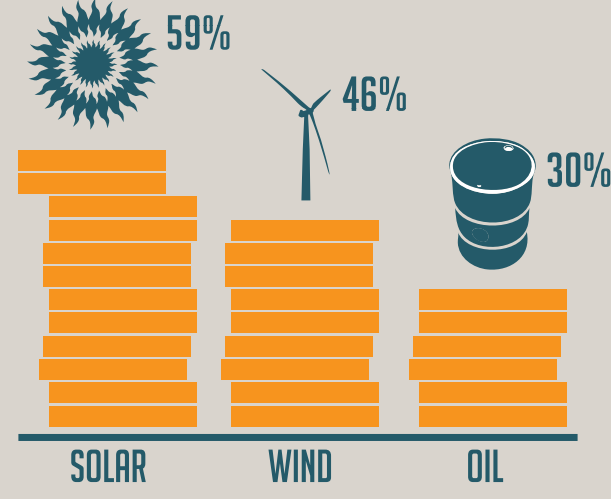

SOLAR AND WIND ARE SEEN AT THE TOP OF THE LIST IN TERMS OF ENERGY SOURCES RECEIVING MOST SUBSIDIES



1/3 RESPONDENTS IDENTIFY OIL AMONG THE MOST HEAVILY SUBSIDISED SOURCES OF ENERGY

FOR THE FIRST TIME, SPONTANEOUS ATTRIBUTIONS BETWEEN A RANGE OF ADJECTIVES AND DIFFERENT ENERGY SOURCES HAVE BEEN ANALYSED

INDISPENSIBLE GREEN



SOLAR

DANGEROUS DAMAGING FOR HEALTH EXPENSIVE UGLY



NUCLEAR



OIL



SAY THE REASON FOR SOME WARS IS MAINLY TO DEFEND ECONOMIC INTERESTS CONNECTED TO OIL AND GAS PRODUCTION

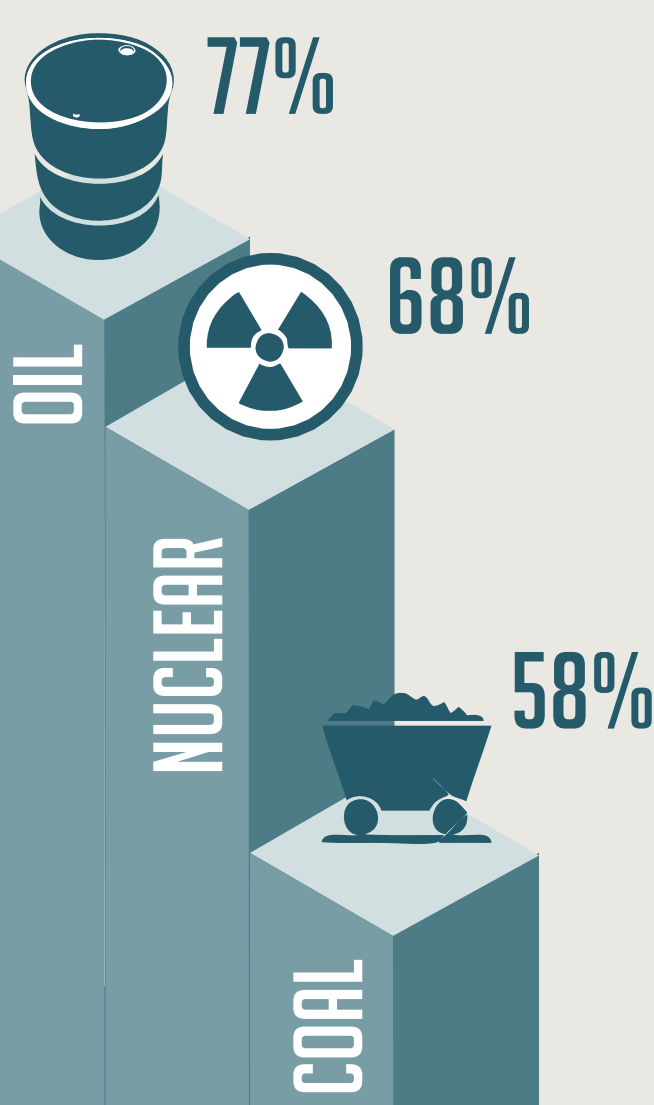
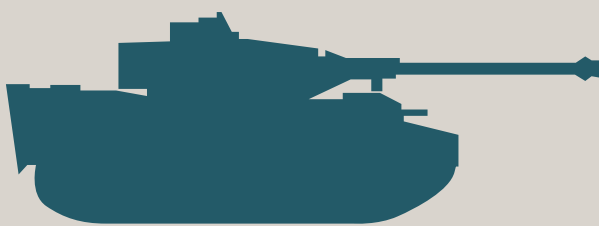

ENERGY SOURCES WITH THE BIGGEST IMPACT ON THE ENVIRONMENT

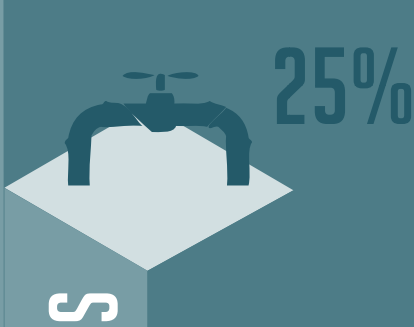

GAS



BIOMASS

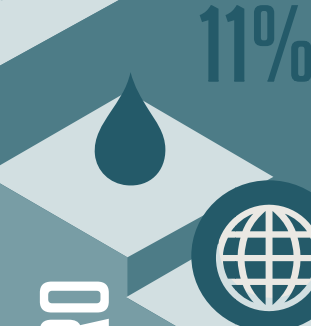

HYDRO

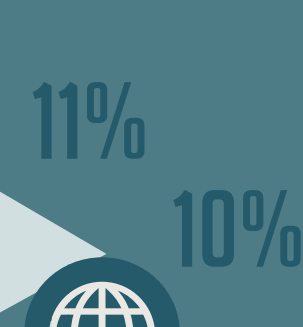

GEOTHERMAL



SOLAR



WIND